

INSTALLATION INSTRUCTIONS

JACLO®

Confidence from start to finish.™

Wall Mounted Accessories

Part #'s:

Roaring 20's/Westfield: 4830-RH, 4830-TR, 4830-TB-24, 4830-TB-18, 4830-TP, 4830-SD, 4830-TH, 4830-GS-24

Astor: 4870-RH, 4870-TR, 4870-TB-24, 4870-TB-18, 4870-TP, 4870-SD, 4870-TH, 4870-GS-24

Jaylen: 4840-RH, 4840-TR, 4840-TB-24, 4840-TB-18, 4840-TP, 4840-SD, 4840-TH, 4840-GS-24

Styles vary. Astor shown.

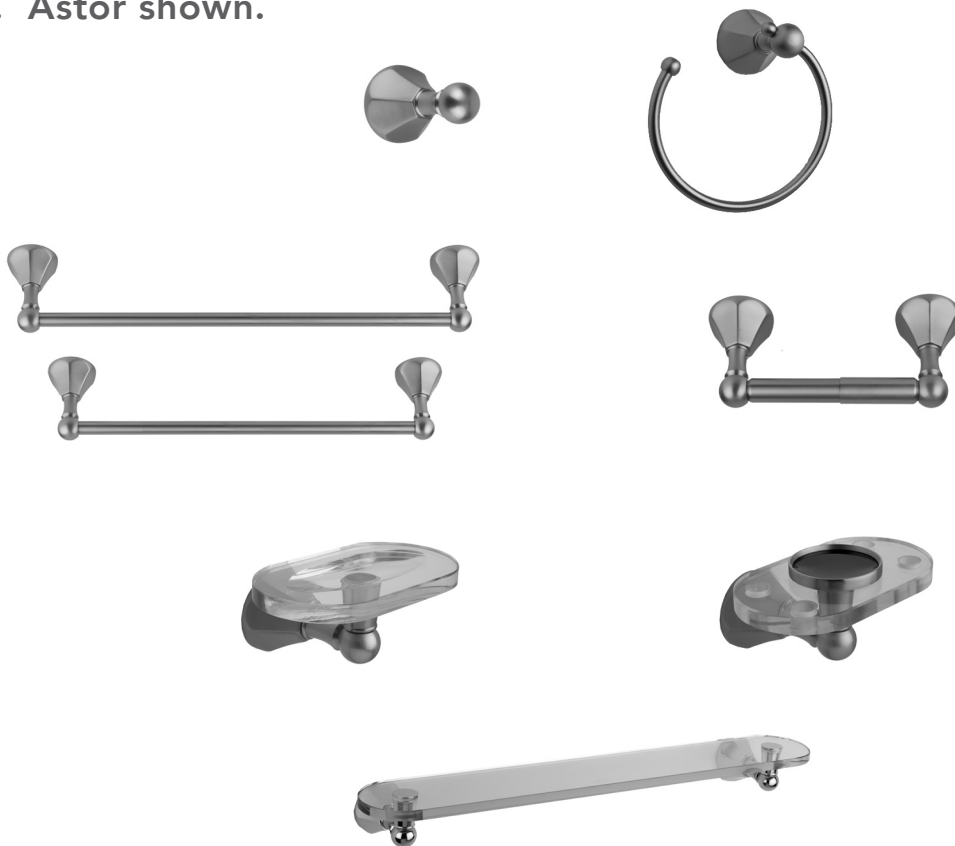

STYLES:

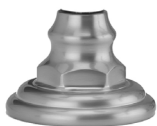

Roaring 20s/Westfield



Astor



Jaylen

ITEM	DESCRIPTION	PART #
1	Mounting Post	4800-MF-0
2	Screw	7905-ZP-0
3	Plastic Wall Anchor	7905-ZP-0
4	Metal Wall Anchor	7905-ZP-0
5	Escutcheon	Varies on model
6	Accessory Post	Varies on model
7	Set Screw (2)	30466-0
8	Hex Wrench	30845-0
9	Left T.P. Tube	TP-6-L-**
10	Spring	TP-7-0
11	Right T.P. Tube	TP-6-R-**
12	Soap Dish or Tumbler Holder	4800-GI-**
13	'O' Ring	
14	Escutcheon	Varies on model
16	24" Towel Bar	4800-24-BAR-**
16	24" Glass Shelf	4800-GS-0
17	18" Towel Bar	4800-18-BAR

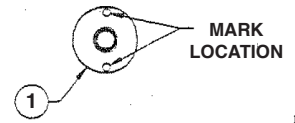

Fig. 1

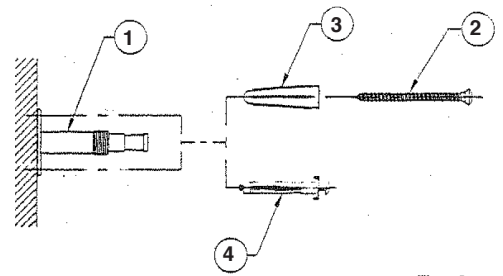

Fig. 2

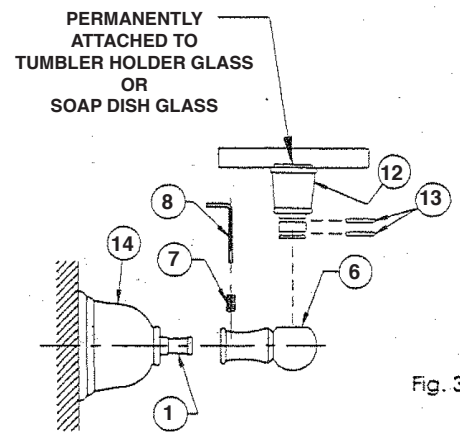

Fig. 3

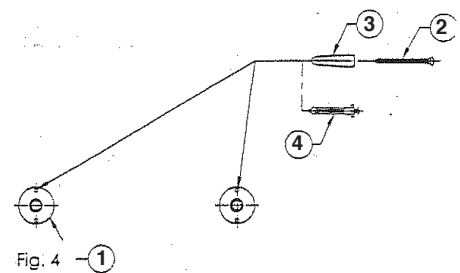
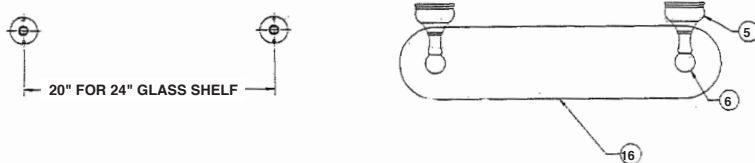
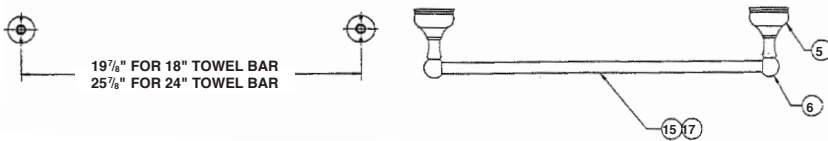
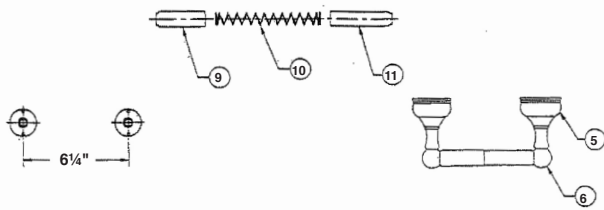

Fig. 4

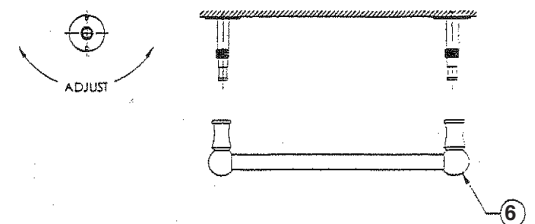

Fig. 5

SINGLE POST INSTALLATION FOR:

Robe hook, Towel ring, Toilet Paper Holder

1. Place mounting post **(1)** on wall in desired location and mark location of mounting holes **(Fig. 1)**.
2. Select the hardware **(2 & 3)** or **(4)** that best suits your application and secure mounting post **(1)** to wall **(Fig. 2)**.
3. Place mounting post **(1)** on wall in desired location and mark location of mounting holes **(Fig. 1)**.
4. Slide accessory post **(6-varies with accessory)** onto mounting post **(1)** until it touches the top of escutcheon **(5)** and secure with set screw **(7)**.

DOUBLE POST INSTALLATION FOR:

Toilet Paper Holder, Towel Bar, Glass Shelf

1. Select the hardware **(2 & 3)** or **(4)** and attach both mounting posts **(1)** to the wall using the top mounting hole only **(Fig. 4)**. Select correct center line for accessory. Tighten mounting screw lightly. Do not secure.
2. Loosely assemble accessory with accessory post **(6)** onto mounting post. Adjust mounting post as shown and mark location for second mounting screw **(Fig. 5)**.
3. Remove accessory and secure mounting post to wall using remaining hardware.
4. Thread escutcheon **(5 -style varies)** onto mounting post **(1)**.
5. Slide accessory with accessory post **(6)** onto mounting post **(1)** until it touches the top of escutcheon **(5)** and secure with set screw **(7)**.

To learn more about JACLO's warranty, please visit [**jaclo.com**](http://jaclo.com)