

INSTALLATION INSTRUCTIONS

JACLO zeroEDGE® and SLIM CHANNEL DRAINS

Part #'s: 88224, 88232, 88236, 88242, 88248, 88260
85224, 85232, 85236, 85242, 85248, 85260
83224, 83232, 83236, 83242, 83248, 83260



Figure 1

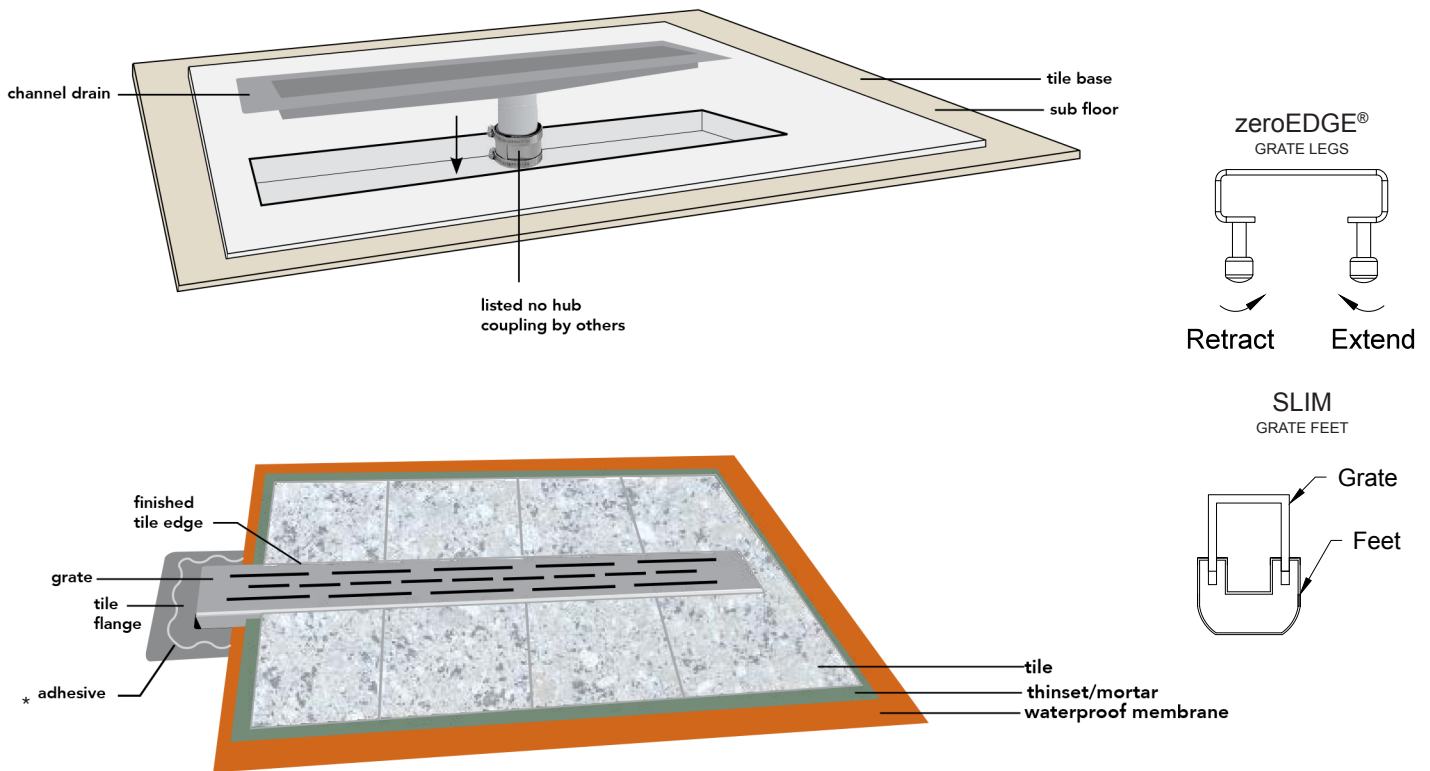

* Adhesive must be compatible with 304 Stainless Steel

INSTALLATION

1. Determine location for channel drain
2. Install subfloor and base layer adhering to local codes
3. Cut hole in floor allowing additional 1/4". Allow access to fit and clamp no hub coupling. See Fig. 1
4. Install no hub coupling onto channel drain
5. Apply a bead of silicone caulking to the underside of tile flange
6. Install channel drain, by attaching no hub coupling to existing piping
7. ANSI A118.10 compliant membrane must be used for this installation. Cut membrane to match opening in channel drain base
8. Install waterproof membrane as per manufacturer's instructions. Adhere membrane to tile flange on channel drain using membrane manufacturer's recommended adhesive
9. Apply thin set mortar and install tile
10. Once above is completed and dry, install channel drain grate
11. Install grate in channel drain base. If required, adjust legs on grate level with tile profile. Legs extend clockwise rotation or retract counter clockwise rotation. Adjust all legs to base to distribute grate level evenly on base

882XX-BSS

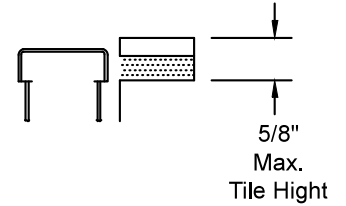
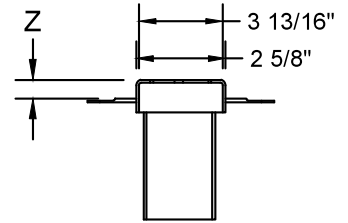
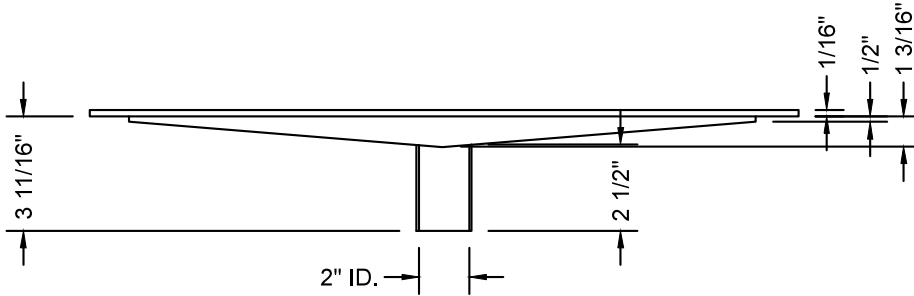

| TILE HEIGHT ABOVE FLANGE (Grate Height) | | |
|--|-----------|-----------|
| PART. # | Z Min. | Z Max. |
| 88224-BSS | 9/16" | 1" |
| 88232-BSS | 9/16" | 1" |
| 88236-BSS | 11/16" | 1 1/8" |
| 88242-BSS | 9/16" | 1" |
| 88248-BSS | 9/16" | 1" |
| 88260-BSS | 5/8" | 1 1/16" |

852XX-BSS

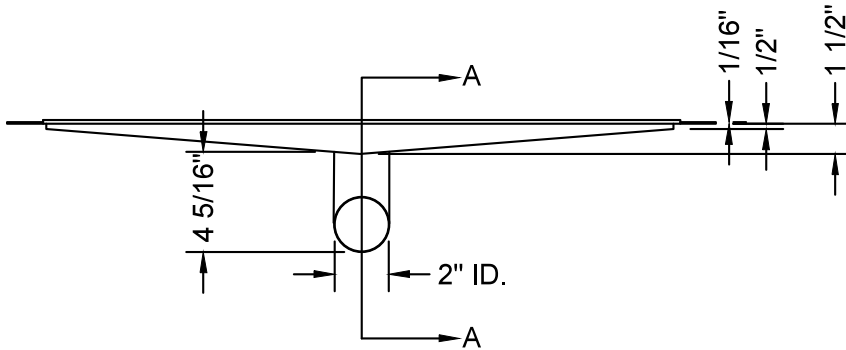

DETAIL A

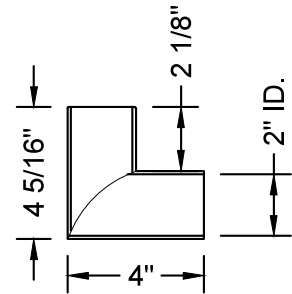

| TILE HEIGHT ABOVE FLANGE (Grate Height) | | |
|--|-----------|-----------|
| PART. # | Z Min. | Z Max. |
| 85224-BSS | 9/16" | 1" |
| 85232-BSS | 9/16" | 1" |
| 85236-BSS | 11/16" | 1 1/8" |
| 85242-BSS | 9/16" | 1" |
| 85248-BSS | 9/16" | 1" |
| 85260-BSS | 5/8" | 1 1/16" |

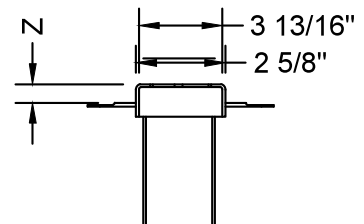

To learn more about JACLO's warranty, please visit [**jaclo.com**](http://jaclo.com)